

Technical Data Sheet
OPTO INTERRUPTER ITR

ITR9904

■ **Features**

- Fast response time
- High analytic
- Cut-off visible wavelength $\lambda p=940\text{nm}$
- High sensitivity
- This product itself will remain within RoHS compliant version.



■ **Descriptions**

The **ITR9904** consists of an infrared emitting diode and an NPN silicon phototransistor, encased oblique angle (45°) on converging optical axis in a black Thermo-plastic housing. The phototransistor receives radiation from the IRED only, and avoids the noise from ambient light.

■ **Applications**

- Copier
- Scanner
- Non-contact Switching
- For Direct PC Board

■ **Device Selection Guide**

Device No.	Chip Material	LENS COLOR
IR1254-R8	GaAs	Blue
PT1254-6B	Silicon	Black

Technical Data Sheet
OPTO INTERRUPTER ITR

ITR9904

Package Dimensions

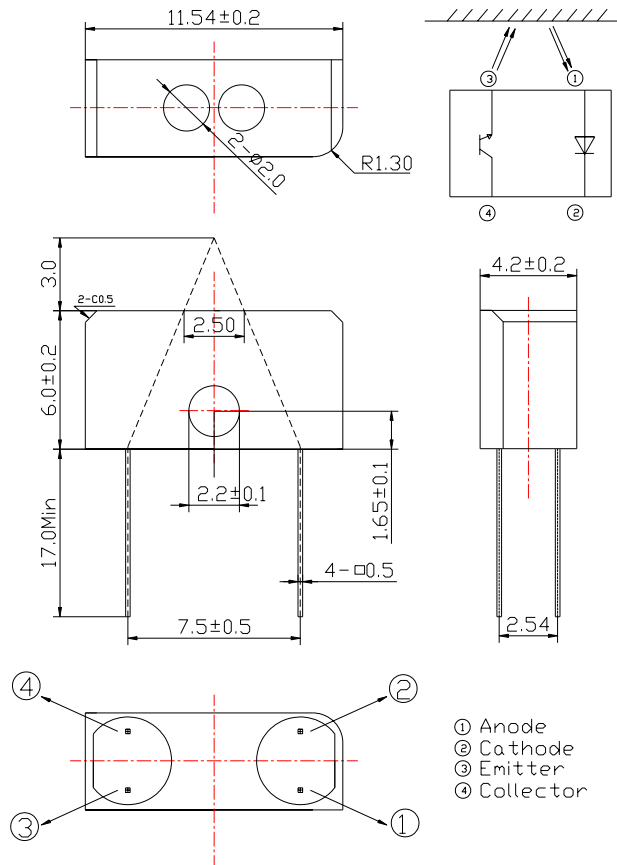

Notes:

1. All dimensions are in millimeter.
2. General tolerance: ± 0.2 mm
3. Lead spacing is measured where the lead emerge from the package.
4. Above specification may be changed without notice. EVERLIGHT will reserve authority on material change for above specification.
5. These specification sheets include materials protected under copy right of EVERLIGHT corporation . Please don't reproduce or cause anyone to reproduce them without EVERLIGHT's consent.
6. When using this product , please observe the absolute maximum ratings and the instructions for use outlined in these specification sheets. EVERIGHT assumes noonsibility for any damage resulting from use of the product which does not comply with the absolute maximum ratings and the instructions included in these specification sheets.



Technical Data Sheet

OPTO INTERRUPTER ITR

ITR9904

■ Absolute Maximum Ratings (Ta=25°C)

Parameter		Symbol	Rating	Unit
Input	Power Dissipation	P_D	75	mW
	Reverse Voltage	V_R	5	V
	Forward Current	I_F	50	mA
	Peak Forward Current(*1)	I_{FP}	1.0	A
Output	Collect Power Dissipation	P_C	75	mW
	Collect Current	I_C	20	mA
	Collector-Emitter Voltage	V_{CE}	30	V
	Emitter-Collector Voltage	V_{EC}	5	V
Operating Temperature		T_{opr}	-25~+85	°C
Storage Temperature		T_{stg}	-40~+85	°C
Soldering Temperature(*2)		T_{sol}	260	°C

(*1) Pause width= 100 μ s, Duty Cycle=1%

(*2) t=5 secs_



Technical Data Sheet

OPTO INTERRUPTER ITR

ITR9904

Electro-Optical Characteristics (Ta=25°C)

Parameter		Symbol	Min.	Typ.	Max.	Unit	Condition
Input	Forward Voltage	V_{F1}	-	1.2	1.5	V	$I_F=20mA$
		V_{F2}	-	1.4	1.85		$I_F=100mA$
		V_{F3}	-	2.6	4.0		$I_F=1A$
	Reverse Current	I_R	-	-	10	μA	$V_R=5V$
	Peak Wavelength	λ_P	-	940	-	nm	---
	View Angle	$2\theta_{1/2}$	-	35	-	Deg	$I_F=20mA$
Output	Dark Current	I_{CEO}	-	-	100	nA	$V_{CE}=20V, E_e=0mW/cm^2$
	C-E Saturation Voltage	$V_{CE(sat)}$	-	-	0.4	V	$I_C=2mA, I_B=0.1mA$
Collect Current		$I_{C(ON)A}$	100	-	300	μA	$V_{CE}=5V, I_F=20mA$
		$I_{C(ON)B}$	200	-	600		
		$I_{C(ON)C}$	400	-	1200		
Response Time	Rise Time	t_R	-	15	-	μS	$V_{CE}=2V, I_C=1mA, R_L=1K\Omega$
	Fall Time	t_F	-	15	-	μS	

Technical Data Sheet
OPTO INTERRUPTER ITR

ITR9904

Typical Electrical/Optical/Characteristics Curves for IR

Fig. 1 Forward Current vs. Ambient Temperature

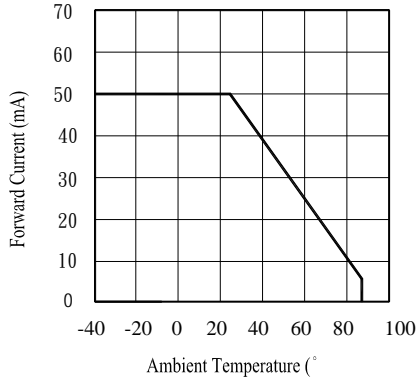

Fig. 2 Spectral Distribution

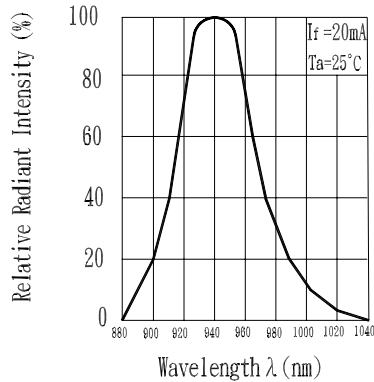

Fig. 3 Peak Emission Wavelength vs. Ambient Temperature

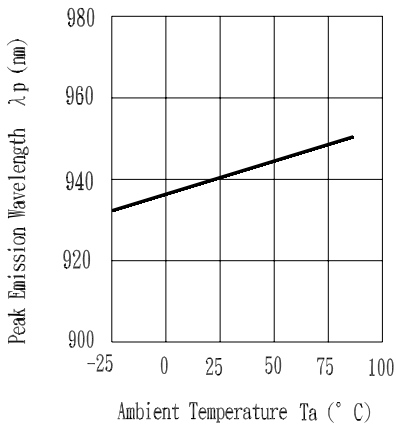

Fig. 4 Forward Current vs. Forward Voltage

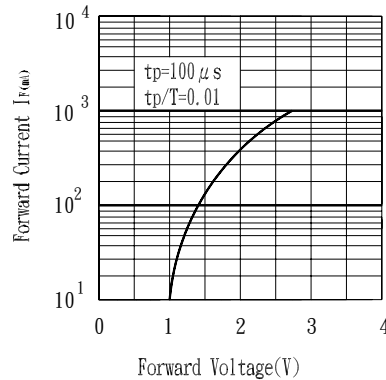

Fig. 5 Relative Intensity vs. Forward Current

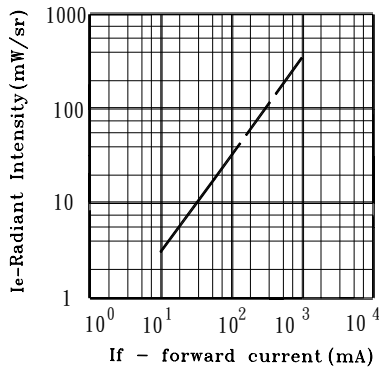
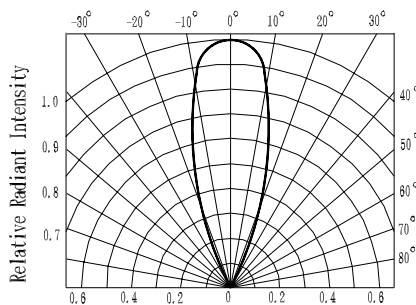

Fig. 6 Relative Radiant Intensity vs. Angular Displacement



Technical Data Sheet
OPTO INTERRUPTER ITR

ITR9904

Typical Electrical/Optical/Characteristics Curves for PT

Fig.1 Collector Power Dissipation vs. Ambient Temperature

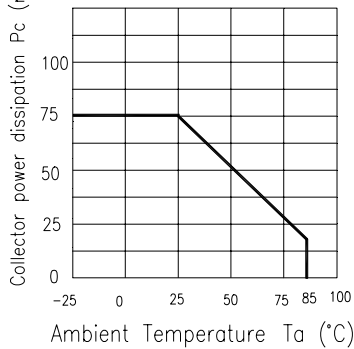

Fig.2 Collector Dark Current vs. Ambient Temperature

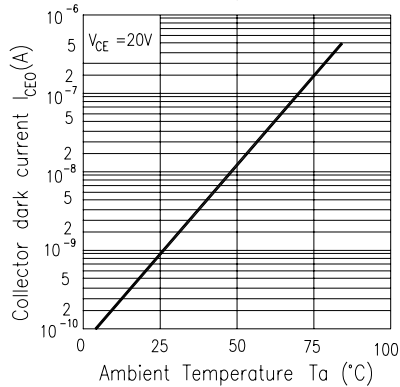

Fig. 3 Relative Collector Current vs. Ambient Temperature

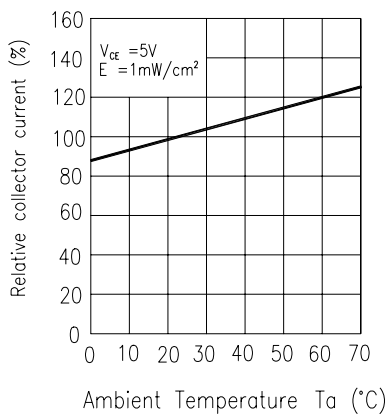

Fig.4 Collector Current vs. Irradiance

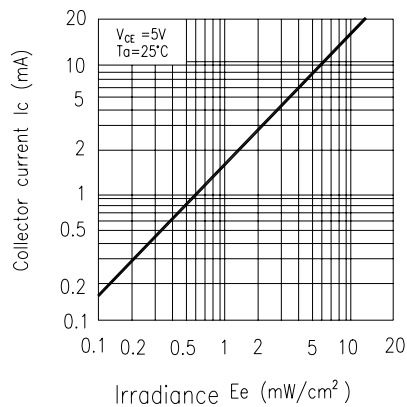

Fig.5 Spectral Sensitivity

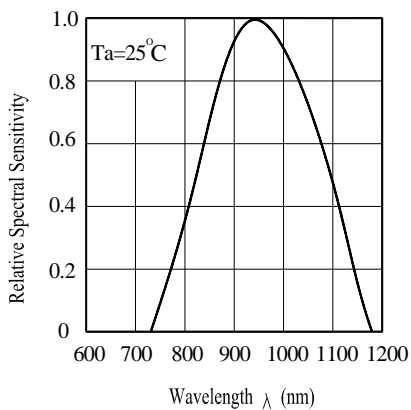
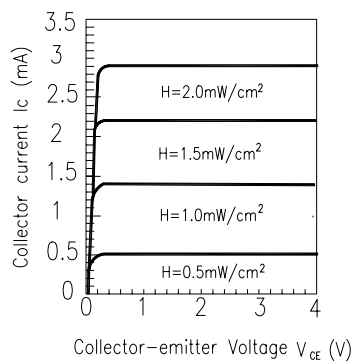

Fig.6 Collector Current vs. Collector-emitter Voltage





Technical Data Sheet

OPTO INTERRUPTER ITR

ITR9904

■ Reliability Test Item And Condition

The reliability of products shall be satisfied with items listed below.

Confidence level : 90%

LTPD : 10%

NO.			Test Hours/ Cycle	Sample Size	Failure Judgement Criteria	Ac/Re
1	Solder Heat	TEMP : 260°C ± 5 °C	10 sec	22 PCs	$I_{c(on)} \leq L \times 0.8$ L : Lower specification limit	0/1
2	Temperature Cycle	H : +100°C 15 min L : -40°C 15 min	300 cycle	22 PCs		0/1
3	Thermal Shock	H : +100°C 5 min L : -10°C 5 min	300 cycle	22 PCs		0/1
4	High Temperature Storage	TEMP. : +100°C	1000 hrs	22 PCs		0/1
5	Low Temperature Storage	TEMP. : -40°C	1000 hrs	22 PCs		0/1
6	DC Operating Life	$V_{CE}=5V$ $I_F=20mA$	1000 hrs	22 PCs		0/1
7	High Temperature / High Humidity	85°C / 85% R.H.	1000 hrs	22 PCs		0/1



Technical Data Sheet
OPTO INTERRUPTER ITR

ITR9904

■ **Packing Quantity Specification**

150 pcs/1bag , 5 bags/1box , 10 boxes/1carton

■ **Label Form Specification**



CPN:

P/N:



ITR9904

QTY:



LOT NO:

CAT:

HUE:

REF:



CPN: Customer's Production Number

P/N : Production Number

QTY: Packing Quantity

CAT: Ranks

HUE: Peak Wavelength

REF: Reference

LOT No: Lot Number

■ **Notes**

1. Above specification may be changed without notice. EVERLIGHT will reserve authority on material change for above specification.
2. When using this product, please observe the absolute maximum ratings and the instructions for using outlined in these specification sheets. EVERLIGHT assumes no responsibility for any damage resulting from use of the product which does not comply with the absolute maximum ratings and the instructions included in these specification sheets.
3. These specification sheets include materials protected under copyright of EVERLIGHT corporation. Please don't reproduce or cause anyone to reproduce them without EVERLIGHT's consent.

EVERLIGHT ELECTRONICS CO., LTD.

Office: No 25, Lane 76, Sec 3, Chung Yang Rd,
Tucheng, Taipei 236, Taiwan, R.O.C

Tel: 886-2-2267-2000, 2267-9936

Fax: 886-2267-6244, 2267-6189, 2267-6306
<http://www.everlight.com>